

**UNI-T®**

**Model UT81A/B  
OPERATING MANUAL**

## Table of Contents

| Chapter                                    | Title  | Page |
|--|--|------|
| 1  | <b>Before You Start</b> .....                      | 6    |
|  | Overview .....                                     | 6    |
|  | Unpacking Inspection .....                         | 7    |
|  | Safety Information .....                           | 8    |
|  | Rules For Safe Operation .....                     | 8    |
|  | International Electrical Symbols .....             | 10   |
| 2  | <b>Using The Testing Tool</b> .....                | 11   |
|  | Reading the screen .....                           | 11   |
|  | The Meter Structure .....                          | 12   |
|  | Functional Buttons .....                           | 13   |
| 3  | <b>Making Measurements</b> .....                   | 15   |
|  | A. Scope Mode .....                                | 15   |
|  | i. Setting up the Sleep Mode, Contrast, Beep ..... | 15   |
|  | ii. ACV, DCV, Hz, ACV and DCA Range .....          | 17   |
|  | iii. Trigger function .....                        | 19   |
|  | iv. Waveform data save and recall .....            | 19   |
|  | B. Digital Multimeter Mode .....                   | 20   |
|  | i. Measuring Voltages .....                        | 20   |
|  | ii. Measuring Currents .....                       | 22   |
|  | iii. Measuring Resistance .....                    | 27   |
|  | iv. Testing Diodes .....                           | 29   |
|  | v. Testing for Continuity .....                    | 31   |
| vi. Measuring Frequency / Duty Cycle ..... | 33   |      |

### Table of Contents

| Chapter  | Title   | Page      |
|----------|---|-----------|
|          | vii. Measuring Capacitance .....                  | 35        |
| <b>4</b> | <b>Using Software</b> .....                       | <b>37</b> |
| <b>5</b> | <b>Maintenance The Test Tool</b> .....            | <b>38</b> |
|          | A. General Service .....                          | 38        |
|          | B. Replacing the Fuses .....                      | 39        |
|          | C. Replacing the Battery .....                    | 40        |
| <b>6</b> | <b>Specifications</b> .....                       | <b>41</b> |
|          | Safety and Compliances .....                      | 41        |
|          | Physical Specifications .....                     | 42        |
|          | General Specifications (Digital Multimeter) ..... | 43        |
|          | General Specifications (Scope) .....              | 43        |
|          | Feature Summary .....                             | 44        |
|          | Basic Specifications (Digital Multimeter) .....   | 44        |
|          | Basic Specifications (Scope) .....                | 45        |
|          | Detailed Accuracy Specifications .....            | 45        |
|          | A. DC Voltage .....                               | 46        |
|          | B. AC Voltage .....                               | 46        |
|          | C. DC Current .....                               | 47        |
|          | D. AC Current .....                               | 48        |
|          | E. Resistance .....                               | 49        |
|          | F. Diode Test .....                               | 49        |
|          | G. Continuity Test .....                          | 50        |

|                |                                     | <b>Table of Contents</b> |
|----------------|-------------------------------------|--------------------------|
| <b>Chapter</b> | <b>Title</b>                        | <b>Page</b>              |
|                | H. Frequency and Duty Cycle % ..... | 50                       |
|                | I. Capacitance .....                | 51                       |

|              |  | <b>List of Tables</b> |
|--------------|--|-----------------------|
| <b>Table</b> | <b>Title</b>                           | <b>Page</b>           |
| 1-1          | Unpacking Inspection .....             | 7                     |
| 1-2          | International Electrical Symbols ..... | 10                    |
| 2-1          | Reading the Screen .....               | 11                    |
| 2-2          | Functional Buttons .....               | 13                    |

## List of Tables

| <b>Figure</b> | <b>Title</b>                             | <b>Page</b> |
|---------------|--|-------------|
| 2-1           | Meter Structure -----                    | 12          |
| 2-2           | Functional Buttons -----                 | 13          |
| 3-1           | Waveform Display -----                   | 17          |
| 3-2           | Voltages Measurement -----               | 21          |
| 3-3           | $\mu$ A Range Measurement -----          | 23          |
| 3-4           | mA Range Measurement -----               | 24          |
| 3-5           | 10A Range Measurement -----              | 25          |
| 3-6           | Resistance Measurement -----             | 27          |
| 3-7           | Diode Test -----                         | 29          |
| 3-8           | Continuity Test -----                    | 31          |
| 3-9           | Frequency / Duty Cycle Measurement ----- | 33          |
| 3-10          | Capacitance Measurement -----            | 35          |
| 5-1           | Fuse Replacement -----                   | 39          |
| 5-2           | Battery Replacement -----                | 40          |

### Chapter 1 Before You Start

#### Overview

This Operating Manual covers information on safety and cautions. Please read the relevant information carefully and observe all the **Warnings** and **Notes** strictly.



#### Warning

**To avoid electric shock or personal injury, read the “Safety Information” and “Rules for Safe Operation” carefully before using the Meter.**

Scope Digital Multimeter **UT81A/B** (hereafter referred to as “the Meter”) is a 3999 counts and 3 3/4 digits adopting digital control technique with both waveform and multimeter all in one.

Scope mode is a complete intelligent measurement system including signal input, sampling, data process, auto search and waveform save and recall. It has

bandwidth UT81A:2MHz,UT81B:8MHz, real-time sample rate 40MS/s with peak rate sampling process can catch up pulse industrial signal. It can measure AC/DC engine, transducer, circuit, control, UPS and industrial equipments. It is an ideal tools in professional repairing industries.

Digital Multimeter mode can measure AC voltage and current, DC voltage and current, Resistance, Capacitance, Frequency, Duty Cycle, Diodes and Continuity.

### Unpacking Inspection

Open the package case and take out the Meter. Check the items shown on Table 1-1 carefully to see any missing or damaged part:

Table 1-1. Unpacking Inspection

| Item | Description   | Qty      |
|------|---|----------|
| 1    | English Operating Manual                                  | 1 piece  |
| 2    | USB interface cable                                       | 1 piece  |
| 3    | CD-ROM (Installation Guide & Computer Interface Software) | 1 piece  |
| 4    | Test Lead   | 1 pair   |
| 5    | Alligator Clip  | 1 piece  |
| 6    | Power Adaptor   | 1 piece  |
| 7    | 1.5V Batteries (R6)                                       | 4 pieces |
| 8    | Carrying bag  | 1 piece  |
| 9    | Scope Probe (available at extra cost)                     | 1 piece  |
| 10   | BNC probe (available at extra cost)                       | 1 piece  |

In the event you find any missing or damage, please contact your dealer immediately.



### Safety Information

This Meter complies with the standards IEC61010 safety measurement requirement: in pollution degree 2, overvoltage category (CAT. II 1000V, CAT.III 600V) and double insulation.

CAT.II: Local level, appliance, PORTABLE EQUIPMENT etc., with smaller transient overvoltages than CAT. III  
CAT. III: Distribution level, fixed installation, with smaller transient overvoltage than CAT. IV

Use the Meter only as specified in this operating manual, otherwise the protection provided by the Meter may be impaired.

In this manual, a **Warning** identifies conditions and actions that may pose hazards to the user, or may damage the Meter or the equipment under test.

A **Note** identifies the information that user should pay attention to.

International electrical symbols used on the Meter and in this Operating Manual are explained on page 10.

### Rules For Safe Operation

#### Warning

**To avoid possible electric shock or personal injury, and to avoid possible damage to the Meter or to the equipment under test, adhere to the following rules:**

- **Before using the Meter inspect the case. Do not use the Meter if it is damaged or the case (or part of the case) is removed. Look for cracks or missing plastic. Pay attention to the insulation around the connectors.**
- **Inspect the test leads for damaged insulation or exposed metal. Check the test leads for continuity. Replace damaged test leads with identical model number or electrical specifications before using the Meter.**
- **Do not apply more than the 1000V rms between any terminal and grounding to avoid electric**

shock or damages to the Meter.

- 1 The rotary switch should be placed in the right position and no any changeover of range shall be made during measurement is conducted to prevent damage of the Meter.
- 1 When the Meter working at an effective voltage over 60V in DC or 42V rms in AC, special care should be taken for there is danger of electric shock.
- 1 Use the proper terminals, function, and range for your measurements.
- 1 Do not use or store the Meter in an environment of high temperature, humidity, explosive, inflammable and strong magnetic field. The performance of the Meter may deteriorate after dampened.
- 1 When using the test leads, keep your fingers behind the finger guards.
- 1 Disconnect circuit power and discharge all high-voltage capacitors before testing resistance, continuity, diodes.
- 1 Before measuring current, check the Meter's fuses and turn off power to the circuit before

connecting the Meter to the circuit.











- 1 Replace the battery as soon as the battery indicator  appears. With a low battery, the Meter might produce false readings that can lead to electric shock and personal injury.
- 1 When servicing the Meter, use only the same model number or identical electrical specifications replacement parts.
- 1 The internal circuit of the Meter shall not be altered at will to avoid damage of the Meter and any accident.
- 1 Soft cloth and mild detergent should be used to clean the surface of the Meter when servicing. No abrasive and solvent should be used to prevent the surface of the Meter from corrosion, damage and accident.
- 1 The Meter is suitable for indoor use.
- 1 Turn the Meter off when it is not in use and take out the battery when not using for a long time.
- 1 Constantly check the battery as it may leak when it has been using for some time, replace the battery as soon as leaking appears. A leaking battery will damage the Meter.

- 1 Under the influence of Radiated Radio-Frequency Electromagnetic Field phenomenon, the captioned model have a 20% measurement error, it will be back to normal when the interference is removed.

### International Electrical Symbols

Symbols used on the Meter and in this manual are explained in Table1-2.

Table 1-2. International Electrical Symbols

|   |   |
|---|---|
|  | AC or DC                                |
|  | DC Measurement                          |
|  | AC Measurement                          |
|  | Continuity Test                         |
|  | Diode                                   |
|  | Grounding                               |
|  | Double Insulated                        |
|  | Warning. Refer to the Operating Manual  |
|  | Deficiency of Built-In Battery          |
|  | Conforms to Standards of European Union |

## Chapter 2 Using the Testing Tool

### Reading the Screen

The screen displays the menu that provides the following choices available:

Table 2-1. Reading the Screen

| Display  | Description            |
|----------|------------------------|
| Contrast | The degree of contrast |
| Auto Off | Sleep mode time        |
| BK Light | Display backlight      |
| BEEP     | Beeper on and off      |
| ENTER    | Confirm                |
| ▲        | Increase               |
| ▼        | Decrease               |
| MOVE ▲   | Waveform moves up      |
| MOVE ▼   | Waveform moves down    |
| RANG▲    | Increase a range       |

Table 2-1. Reading the Screen

| Display | Description              |
|---------|--------------------------|
| RANG▼   | Decrease a range         |
| BASE ▲  | Increase a time base     |
| BASE ▼  | Decrease a time base     |
| BASE >  | Waveform moves right     |
| BASE <  | Waveform moves left      |
| TRIG ▲  | Trigger moves up         |
| TRIG ▼  | Trigger moves down       |
| SLOP    | Trigger slope adjustment |
| AUTO    | Auto trigger mode        |
| NORM    | Normal trigger mode      |
| SHOT    | Single trigger mode      |

### The Meter Structure

The Figure 2-1 shows the Meter structure.

1. USB Terminals
2. LCD Display
3. Functional Buttons
4. Rotary Switch
5. Power adaptor Input Terminals
6. 10A Input Terminal
7. mA $\mu$ A Input Terminals
8. COM Input Terminal
9. Other Input Terminals

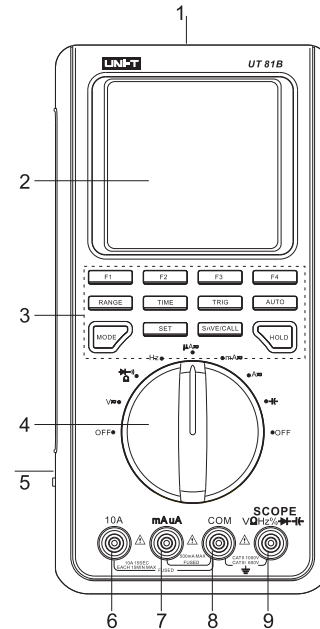

Figure 2-1. Meter Structure

## Functional Buttons

The buttons activate features that augment the function selected with the rotary switch. The buttons are shown in Table 2-2.

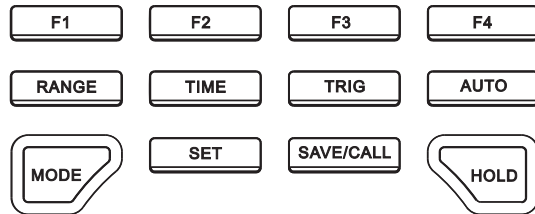

Figure 2-2. Functional Buttons

Table 2-2. Functional Buttons

| Buttons           | Description  |
|-------------------|--|
| F1, F2, F3 and F4 | Software functional buttons, details please refer to the below.  |
| Range             | Under scope mode, Press <b>Range</b> button to switch between DC and AC measurement  |
| Time              | Under scope mode, press <b>Time</b> button to set the X-axis of time base.   |
| Trig              | Under scope mode, press <b>Trig</b> button to change the trigger mode.   |
| Auto              | In multimeter mode: Press <b>Auto</b> button to enter autoranging mode when measuring resistance, voltage and current. This button is invalid when measuring capacitance, diode, continuity buzzer and capacitance.<br>In scope mode: Press <b>Auto</b> button to set the amplitude and time base to auto. |

Table 2-2. Functional Buttons

| Buttons          | Description  |
|------------------|--|
| <b>Mode</b>      | To switch between waveform display (scope mode) and digital reading (multimeter mode). This button is only valid when under voltage, frequency, currents mode. |
| <b>Set</b>       | Press <b>Set</b> button to set the auto power off, backlight, contrast and beep.   |
| <b>Save/Call</b> | Under scope mode, press <b>Save/Cal</b> to store and recall data.  |
| <b>Hold</b>      | Press <b>Hold</b> button to enter or exit hold mode.   |

## Chapter 3 Making Measurement

### Introduction

Chapter 3 explains how to make measurements.

You could turn the Meter off by turning to **OFF** position or set up the sleep mode from 1-30 minutes. Please must ensure the Meter is not under sleep mode if you turn the Meter on but without display.

To avoid false readings, which could lead to possible electric shock or personal injury, replace the battery as soon as the battery indicator “” appears.

### A. Scope Mode

- The LCD top right part display: RUN, HLD, REV
- The LCD top right corner has battery icon to indicate when the battery is lower than 5V.
- Under scope mode, both reading and waveform will be displayed.

### i. Setting up Sleep Mode, Contrast, Beep

Based on the working environment to set up sleep mode, contrast, beep

Press **Set** button to set the auto power off, display backlight, contrast and beep

|                 |                 |                 |             |
|-----------------|-----------------|-----------------|-------------|
| <b>Auto off</b> | <b>Bk Light</b> | <b>Contrast</b> | <b>Beep</b> |
| F1              | F2              | F3              | F4          |

F1: Set auto power off time

|                 |          |           |          |              |
|-----------------|----------|-----------|----------|--------------|
| <b>Auto off</b> | <b>▲</b> | <b>15</b> | <b>▼</b> | <b>ENTER</b> |
| F1              | F2       | F3        | F4       |              |

The time level is from OFF, 1 to 30 minutes. Press F4 to confirm, save and return. Press functional button to exit and the setting remains unchanged.



F2: Set the Display Backlight

**BK Light**    ▲    **15**    ▼    **ENTER**

F1            F2            F3            F4

The brightness level from 0 to 31. Press F4 to confirm, save and return. Press functional buttons to exit, the setting is kept, but will not save. The setting will be lost after power off.

F3: Set the LCD contrast

**Contrast**    ▲    **15**    ▼    **ENTER**

F1            F2            F3            F4

The contrast level from 0 to 31. Press F4 to confirm, save and return. Press functional buttons to exit, the setting is kept, but will not save. The setting will be lost after power off.

F4: Set the beeps features, it can only be used under resistance, diode and continuity measurement.

**Beep**    **ON**    **OFF**    **ENTER**

F1            F2            F3            F4

F2 :    to turn the beep on

F3 :    to turn the beep off

F4 :    to confirm , save and return

Press functional buttons to exit, the setting is kept, but will not save. The setting will be lost after power off.

## Model UT81A/B: OPERATING MANUAL

### ii. ACV, DCV, Hz, ACA and DCA range

Turn the rotary switch to ACV, DCV, Hz, ACA or DCA range, the Meter displays digital reading (Multimeter mode). Press **Mode** to switch to waveform display (scope mode) as below Figure 4. When entering scope mode, time base is auto trace, the amplitude is manual set, you may need to re-set them. You could set the trigger level as well if it is needed. Details of measurement operation of ACV, DC, Hz, ACA or DCA can be seen from B. Digital Multimeter Mode:

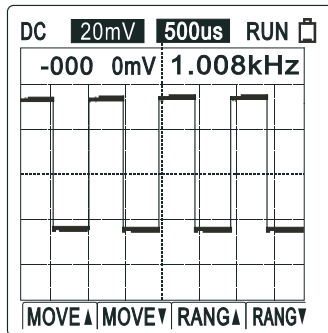

Figure 3-1. Waveform Display

- Press **Range** to switch between DC and AC measurement.
- When the frequency and amplitude of a waveform is unknown, press **Auto** :
  - When the amplitude is set to auto, the amplitude indicator will be shown white text in black background. When the amplitude is set to manual, the amplitude indicator will be shown black text in white background.
  - When the time base is set to auto, the time base indicator will be shown white text in black background. When the time base is set to manual trace, the time base indicator will be shown black text in white background.
  - When the time base is between 20ms - 100ns, it is possible to set the auto. When the time base is between 50ms - 5s, the auto feature will be in valid.

- Y-axis adjustment: Press **Range** button under scope mode, the corresponding functional button:

**Move** ▲ **Move** ▼ **Rang** ▲ **Rang** ▼  
F1 F2 F3 F4

F1: move up the waveform  
F2: move down the waveform  
F3: go up range  
F4: go down a range

The auto set feature will be off when changing the measurement mode

- Press **Time** button under scope mode, the corresponding functional button:

**Base** ▲ **Base** ▼ **Base <** **Base >**  
F1 F2 F3 F4

F1: increase the number of periods  
F2: decrease the number of periods.  
F3: trigger point move left  
F4: trigger point right move

The auto set feature will be off when changing the measurement mode.

### iii. Trigger function

Press **Trig** button under scope mode, the corresponding function buttons:

Trig ▲ Trig ▼ Auto/Norm/Shot Slop Rise/Fall  
 F1      F2                      F3                      F4

- F1: move the trigger level up
- F2: move the trigger level down
- F3: select the trigger mode: auto, normal or single
- F4: slope adjustment: rise or fall

### iv. Waveform data save and recall

Press **Save/Call** button under scope mode, the corresponding functional buttons:

Save/Call    ▲    1    ▼    Enter  
 F1              F2              F3              F4

- F1: save or recall
- F2 and F3: select location (location from 0-9, total

10 location)

F4: confirm

- When saving the data, it will overwrite the current data in the location no matter that location has data or not.
- If you recall the location has no data, the meter will appear error message, you need to press **HOLD** button to continue measurement,
- If you recall the location has data, it will save the current setting and display the data, the LCD top left shows **REV** to indicate recalling mode is on. Press **HOLD** button to return to working mode and continue measurement. You could continue recalling under recall mode or save the data.
- Recall mode can be used under any scope mode. For example, it is possible to recall the waveform or data saved from voltage or frequency mode when the meter is under current measurement mode.
- Recall mode can be worked under any waveform mode. For example: the Meter is at current mode but recalling the waveform or data which are saved under voltage or frequency mode. The Meter must

be returned to working mode to carry out measurement.

### *Remarks:*

In order to have more accurate waveform, user can buy an optional BNC probe and scope probe to decrease signal attenuates. The scope probe directly connect to the BNC probe.

When measuring voltage and frequency signal, connect the BNC black probe to the COM input terminal and the red probe to the voltage terminal.

When measuring current signal, connect BNC black probe to the COM terminal and the red probe to mA terminal.

Don't connect the BNC probe to the 10A terminal.

## B. Digital Multimeter Mode

### *i. Measuring Voltages*



**To avoid harms to you or damages to the Meter from electric shock, please do not attempt to measure voltages higher than DC 1000V, AC 750V, although readings may be obtained.**

To measure voltages, set up the Meter as Figure 3-2 and do the following:

1. Insert the red test lead into the **V** terminal and the black test lead into the **COM** terminal.
2. Set the rotary switch to **V** .
3. Connect test leads across with the object being measured.
4. The measured value shows on the display.
5. Press **MODE** button to toggle between Multimeter mode and Scope mode.
6. Press F1 to toggle between AC and DC voltage measurement.

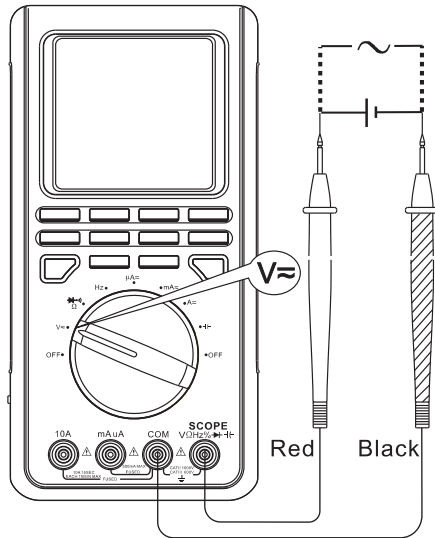

Figure 3-2. Voltages Measurement

When measuring voltage, the corresponding functional buttons

|                |            |               |               |
|----------------|------------|---------------|---------------|
| <b>AC / DC</b> | <b>REL</b> | <b>Rang</b> ▲ | <b>Rang</b> ▼ |
| F1             | F2         | F3            | F4            |

F1: toggle between AC or DC

F2: relative mode (REL will be displayed at the right bottom of the LCD when it is on)

F3: select a range up

F4: select a range down

### Note:

- After changing the measurement mode, the autoranging will be off automatically and the AUTO will be disappeared at the bottom left of the LCD.
- When voltage measurement has been completed, disconnect the connection between the testing leads and the circuit under test and remove testing leads away from the input terminals of the Meter.

## *II. Measuring Currents*

### **Warning**

**If the fuse burns out during measurement, the Meter may be damaged or the operator himself may be hurt.**

**To avoid possible damage to the Meter or to the equipment under test, check the Meter's fuses before measuring current. Use proper terminals, function, and range for the measurement. Never place the testing leads in parallel with any circuit or component when the leads are plugged into the current terminals.**

**Turn off power to the circuit before test leads are connected in series to the return circuit to be tested.**

## Model UT81A/B: OPERATING MANUAL

### ● $\mu\text{A}$ Range Measurement

To measure AC $\mu\text{A}$  or DC $\mu\text{A}$  currents, set up the Meter as Figure 3-3 and proceed as follows:

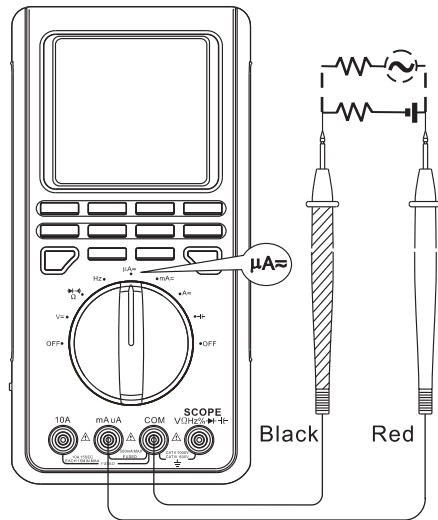

Figure 3-3.  $\mu\text{A}$  Range Measurement

1. Insert the red test lead into the  $\mu\text{mA}$  terminal and black test lead into the **COM** terminal.
2. Set the rotary switch to  $\mu\text{A}$ .
3. Connect the test lead in series with the return circuit to be tested.
4. The measured value shows on the display.
5. Press **MODE** button to toggle between Multimeter mode and Scope mode.
6. Press F1 to toggle between AC and DC current measurement.



### ● mA Range Measurement

To measure ACmA or DcmA currents, set up the Meter as Figure 3-4 and proceed as follows:

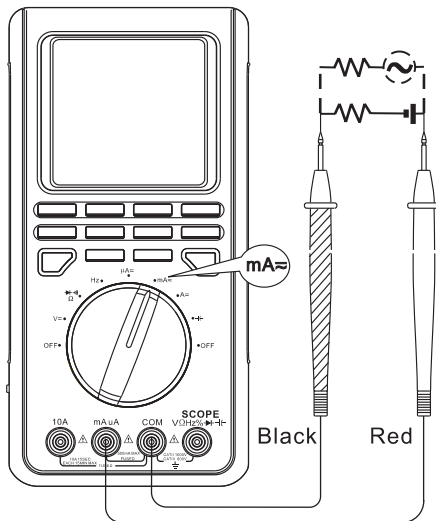

1. Insert the red test lead into the  $\mu\text{mA}$  terminal and black test lead into the **COM** terminal.
2. Set the rotary switch to **mA**.
3. Connect the test lead in series with the return circuit to be tested.
4. The measured value shows on the display.
5. Press **MODE** button to toggle between Multimeter mode and Scope mode.
6. Press **F1** to toggle between AC and DC current measurement.

Figure 3-4. mA Range Measurement

## Model UT81A/B: OPERATING MANUAL

- 10A Range Measurement

To measure AC 10A or DC 10A currents, set up the Meter as Figure 3-5 and proceed as follows:

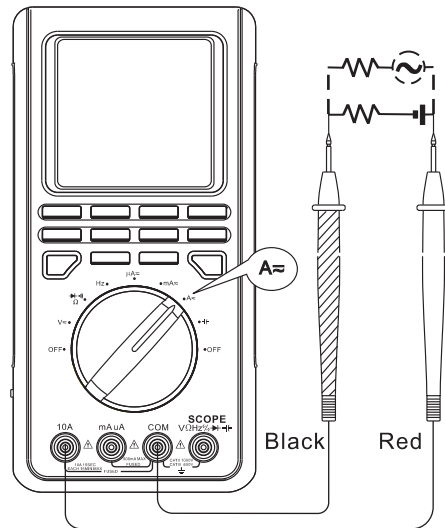

Figure 3-5. 10A Range Measurement

1. Insert the red test lead into the **10A** terminal and black test lead into the **COM** terminal.
2. Set the rotary switch to **A~**.
3. Connect the test lead in series with the return circuit to be tested.
4. The measured value shows on the display.
5. Press **MODE** button to toggle between Multimeter mode and Scope mode.
6. Press **F1** to toggle between AC and DC current measurement.

When measuring current, the corresponding functional buttons:



- F1: toggle between AC or DC
- F2: relative mode (REL will be displayed at the right bottom of the LCD when it is on)
- F3: select a range up
- F4: select a range down

### Note

- After changing the measurement mode, the autoranging will be off automatically and the AUTO will be disappeared at the bottom left of the LCD.
- If the value to be measured is unknown, use the maximum measurement position and reduce the range step by step until a satisfactory reading is obtained.
- When the measured current is  $\leq 5A$ , continuous measurement is allowed.
- When the measured current is between 5A-10A, continuous measurement  $\leq 10$  seconds and interval more than 15 minutes.
- When current measurement has been completed, disconnect the connection between the testing leads and the circuit under test and remove testing leads away from the input terminals of the Meter.

### iii. Measuring Resistance

#### Warning

To avoid possible damages to the Meter or to the devices under test, disconnect circuit power and discharge all the high-voltage capacitors before measuring resistance.

To measure resistance, set up the Meter as shown in Figure 3-6 and follow the following procedure:

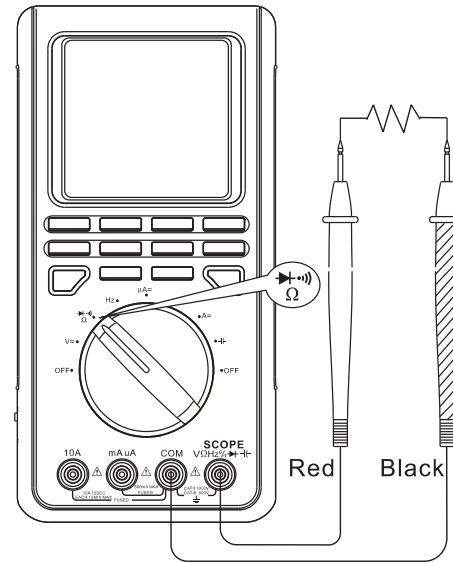

Figure 3-6. Resistance Measurement

1. Insert the red test lead into the  $\Omega$  terminal and the black test lead into the COM terminal.
2. Set the rotary switch to  $\Omega \cdot \text{)} \rightarrow$
3. Connect the test leads across with the object being measured.
4. The measured value shows on the display.

When measuring resistance, the corresponding functional buttons:



- F1: toggle to diode mode  
F2: relative mode  
F3: select to a range up  
F4: select to a range down

### Note

- When measuring low resistance, the test leads can add  $0.1\Omega$  to  $0.2\Omega$  of error to resistance measurement. To test the leads, touch the probe tips together and read the resistance of the leads. Take the reading obtained to subtract the resistance of the leads to get the final reading.
- For high-resistance measurement ( $>1M\Omega$ ) or low resistance measurement ( $<40\Omega$ ), it is normal taking several seconds to obtain a stable reading.
- The LCD displays "OL" indicating open-circuit without input.
- When resistance measurement has been completed, disconnect the connection between the testing leads and the circuit under test and remove testing leads away from the input terminals.

### *iv. Testing Diodes*

#### **Warning**

**To avoid harms to you, please do not attempt to input voltages higher than 60V DC or 42V rms AC.**

**To avoid damages to the Meter or to the devices under test, disconnect circuit power and discharge all the high-voltage capacitors before testing diodes.**

Use the diode test to check diodes, transistors, and other semiconductor devices. The diode test sends a current through the semiconductor junction, then measure the voltage drop across the junction. A good silicon junction drops between 0.5V and 0.8V

To test the diode out of a circuit, set up the Meter as Figure 3-7 and proceed as follows:

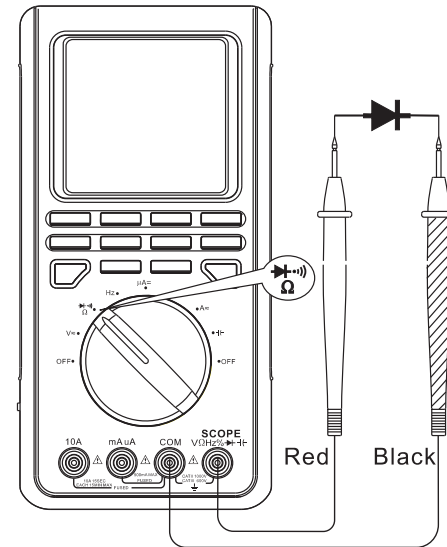

Figure 3-7. Diode Test

1. Insert the red test lead into the  $\Omega$  terminal and the black test lead into the **COM** terminal.
2. Set the rotary switch to  $\Omega \cdot \text{V}$   $\rightarrow$   $\rightarrow$  .
3. For forward voltage drop readings on any semiconductor component, place the red test lead on the component's anode and place the black test lead on the component's cathode. The red test lead polarity is "+" while the black test lead polarity is "—".

The measured value shows on the display.

When measuring diode, the corresponding functional buttons:

**DIODE**      **REL**

F1

F2

F1:      toggle to continuity buzzer

F2:      relative mode

### Note

- Connect the test leads to the proper terminals as said above to avoid error display.
- The LCD will display **OL** indicating either open circuit or wrong polarity connection.
- The unit of diode is volt (V), displaying the positive-connection voltage-drop value.
- When diode testing has been completed, disconnect the connection between the testing leads and the circuit under test and remove the test leads away from the input terminals.

### v. *Testing for Continuity*

#### **Warning**

To avoid harms to you, please do not attempt to input voltage higher than 60V DC or 42V rms AC.

To avoid possible damages to the Meter or to the devices under test, disconnect circuit power and discharge all the high-voltage capacitors before measuring continuity.

To test for continuity, set up the Meter as Figure 3-8 and do the following:

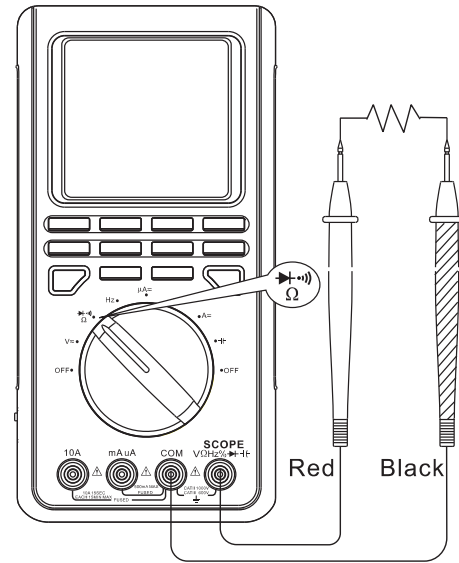

Figure 3-8. Continuity Test



1. Insert the red test lead into the W terminal and the black test lead into the **COM** terminal.
2. Set the rotary switch to  $\Omega \cdot \mu \text{A}$  .
3. Connect the test leads across with the object being tested.
4. The tested circuit overload resistance value shows on the display.
5. The beeper comes on continuously for open conditions, that is test resistance  $<10W$ .
6. The beeper does not sound when the test resistance is  $>100W$

When measuring continuity buzzer, the corresponding functional buttons:



- F1: toggle to resistance measurement mode  
F2: relative mode

### Note

- When continuity testing has been completed, disconnect the connection between the testing leads and the circuit under test and remove the test leads away from the input terminals.

### vi. Measuring Frequency / Duty Cycle



#### Warning

To avoid harms to you, please do not attempt to input voltage higher than 42V rms.

To measure frequency and duty cycle, connect the Meter as Figure 3-9 and do the following:

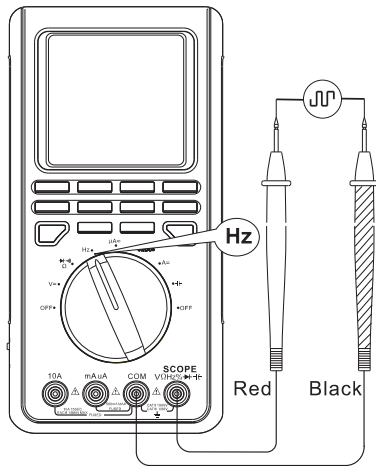

Figure 3-9. Measuring Frequency / Duty Cycle

1. Insert the red test lead into the **Hz** terminal and the black test lead into the **COM** terminal.
2. Set the rotary switch to Hz.
3. Connect the test leads across with the object being measured.
4. The measured value shows on the display.
5. Press **MODE** button to toggle between Multimeter mode and Scope mode.
6. Press F1 to toggle between frequency and duty cycle measurement.

When measuring frequency and duty cycle, the corresponding functional buttons:

**Freq/Duty**

F1

F1: toggle between frequency and duty cycle

## Note

- The requirement of Input amplitude “a” is as follows:  
When  $\leq 1\text{MHz}$ :  $300\text{ mV} \leq a \leq 30\text{Vrms}$ ;  
                   $>1\text{MHz}$ :  $600\text{ mV} \leq a \leq 5\text{Vrms}$
- It is normal to have few seconds run time when switch from other functions to these functions.
- When Hz or duty cycle measurement has been completed, disconnect the connection between the testing leads and the circuit under test and remove the test leads away from the input terminals.

## vii. Measuring Capacitance

### ⚠ Warning

To ensure accuracy, the Meter inside is discharged against the tested capacitor

To avoid damage to the Meter or to the equipment under test, disconnect circuit power and discharge all high-voltage capacitors before measuring capacitance.

To measure capacitance, set up the Meter as shown in Figure 3-10 and proceed as follows:

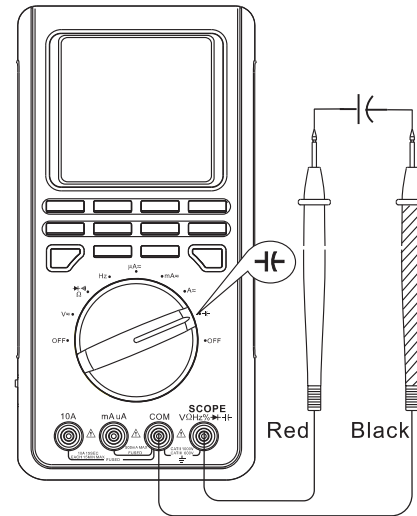

Figure 3-10. Measuring Capacitance

1. Insert the red test lead into **V** terminal and the black test lead into the COM terminal.
2. Set the rotary switch to **V** measurement mode, the Meter may display a fixed reading which is an internal distributed capacitor value. For testing less than 40nF capacitor, the tested value must subtract the internal distributed capacitor value to maintain the accuracy.
3. To improve the accuracy, press F2 REL with the test leads open to subtract the residual capacitance of the Meter and the test leads.
4. It is recommended to use as short as test lead carrying out measurement to reduce the effect of internal distributed capacitor.

When measuring capacitance, the corresponding functional buttons:

|                 |            |
|-----------------|------------|
| <b>Capacity</b> | <b>REL</b> |
| F1              | F2         |

F2: relative mode

### Note

- Capacitors larger than 10 $\mu$ F take longer time.
- If the tested capacitor has polarity, connect the red test lead to positive side and black test lead to negative side.
- When capacitance measurement has been completed, disconnect the connection between the testing leads and the circuit under test and remove the test leads away from the input terminals of the Meter.

## Chapter 4 Using Software

When using the Software, please refer to the Installation Guide of the included CD-ROM.

## Chapter 5 Maintaining The Test Tool

This chapter provides basic maintenance information including battery and fuse replacement instruction.

### **Warning**

**Do not attempt to repair or service your Meter unless you are qualified to do so and have the relevant calibration, performance test, and service information.**

#### **A. General Service**

- 1 Periodically wipe the case with a damp cloth and mild detergent. Do not use abrasives or solvents.
- 1 To clean the terminals with cotton bar with detergent, as dirt or moisture in the terminals can affect readings.
- 1 Turn the Meter to **OFF** when it is not in use.
- 1 Take out the battery when it is not using for a long time.
- 1 Do not use or store the Meter in a place of humidity,

high temperature, explosive, inflammable and strong magnetic field.

## B. Replacing the Fuses

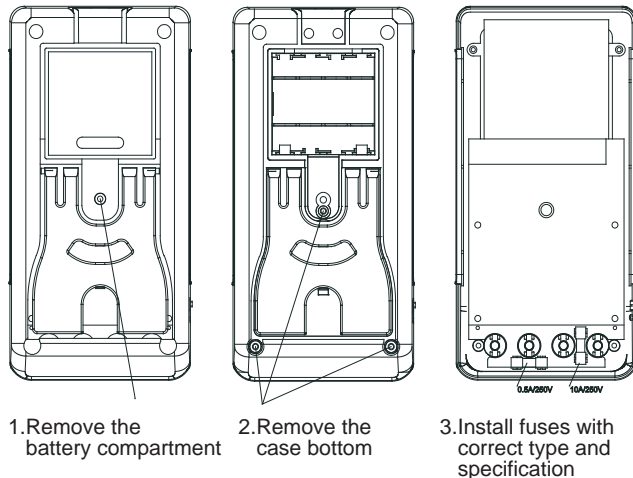

Figure 5-1. Fuse Replacement

### Warning

**To avoid electrical shock or arc blast, or personal injury or damage to the Meter, use specified fuses ONLY in accordance with the following procedure.**

Follow Figure 5-1 and proceed as follows to replace the Meter's fuse:

- 1 Turn the rotary switch to **OFF** and remove all connections from the terminals.
- 1 Remove the screw from the battery compartment, and separate the battery compartment from the case bottom.
- 1 Remove the three screws from the case bottom, and separate the case bottom from the case top.
- 1 Remove the fuse by gently prying one end loose, then take out the fuse from its bracket.
- 1 Install **ONLY** replacement fuses with the identical type and specification as follows and make sure the fuse is fixed firmly in the bracket.
  - Fuse 1: F0.5AH/250V,  $\varnothing 5 \times 20$ mm
  - Fuse 2: F10AH/250V,  $\varnothing 5 \times 20$ mm
- 1 Rejoin the case bottom and case top, battery compartment and case bottom, and install the 5 screws.

Replacement of the fuses is seldom required. Burning of a fuse always results from improper operation.



## C. Replacing the Battery

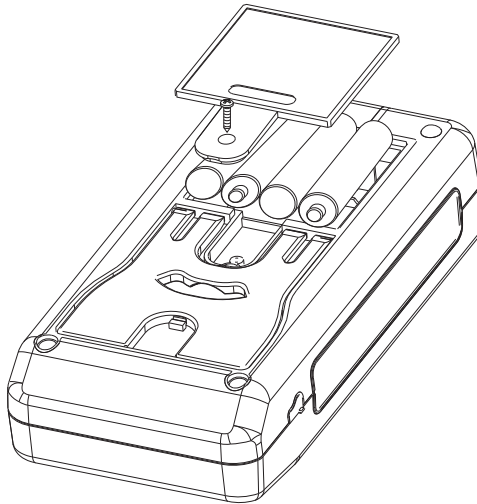



Figure 5-2. Battery Replacement

### Warning

To avoid false readings, which could lead to possible electric shock or personal injury, replace the battery as soon as the battery indicator “” appears.



**Make sure the test leads are disconnected from the circuit being tested before opening the case bottom.**

Follow Figure 5-2 and proceed as follows to replace the battery:

- Turn the rotary switch to OFF and remove all connections from the terminals.
- Remove the screw from the battery compartment, and separate the battery compartment from the case bottom.
- Replace with 4 pieces new 1.5V (R6P) batteries.
- Rejoin the case bottom and battery compartment, and reinstall the screw.

## Chapter 6 Specifications

### Safety and Compliances

|   |  |
|---|--|
| Maximum Voltage between any Terminal and Grounding  | Refer to different range input protection voltage                                |
| Certification   | CE   |
| Compliances   | IEC 61010 CAT. II 1000V, CAT.III 600V overvoltage and double insulation standard |
|  Fused Protection for <b>mA</b> input terminal:  | F0.5AH/250V, ø5x20mm   |
|  Fused Protection for <b>10A</b> input terminal: | F10AH/250V, ø5x20mm  |

### Physical Specifications

|                               |   |
|-------------------------------|---|
| Display (LCD)                 | Digital: 3999 counts on display ; updates 2-3 times / second.   |
| Operating Temperature         | 0°C~40°C (32°F~104°F)   |
| Storage Temperature           | -10°C~50°C (14°F~122°F)   |
| Relative Humidity             | ≤ 75% @ 0°C~40°C;<br>≤ 0% @ -10°C~50°C.   |
| Altitude                      | Operating: 2000m;<br>Storage: 10000m.   |
| Battery Type                  | 1.5V (R6) x 4 Batteries or Power adaptor. Check carefully about the working voltage of power adaptor before use.  |
| Electromagnetic Compatibility | I In a radio field of 1 V/m below:<br>Overall Accuracy = Specified Accuracy + 5% of Range<br>I In a radio field of 1 V/m above:<br>No assigned accuracy is specified. |
| Dimensions (H x W x L)        | 200 x 100 x 48mm.   |
| Weight                        | Approx. 498g (including battery)  |

## General Specifications ( Digital Multimeter)

|                    |   |
|--------------------|---|
| Range              | When it is under Multimeter mode, you could select either auto or manual ranging.         |
| Polarity           | Auto, negative polarity displays “-“  |
| Overloading        | Display <b>OL</b>   |
| Battery Deficiency | Display  |

## General Specifications (Scope)

|              |  |
|--------------|--|
| Display      | 160 x 160 Monochrome                                   |
| Auto setting | Auto set the Meter according to the tested signal size |
| Overloading  | Display <b>OL</b>                                      |
| Memory       | 10 screens and setups                                  |
| USB          | Optically isolated to ensure safety                    |
| Tilt Stand   | Allowing viewing at a convenient position and angle.   |

### Feature Summary

|                     |  |
|---------------------|--|
| Display             | 160 x 160 Monochrome   |
| Autorange           | When it is under multimeter mode, the Meter automatically selects best range |
| Continuity          | Beeper sounds for resistance readings below threshold.                       |
| Duty Cycle          | Measure signal on or off time in %.  |
| Battery Access Door | Battery replaceable.   |

### Basic Specifications (Digital Multimeter)

| Function       | Ranges / Description               |
|----------------|------------------------------------|
| DC Voltage     | 0 to 1000V                         |
| AC Voltage     | 0 to 750V                          |
| Basic Accuracy | DC Voltage: 0.8%<br>AC Voltage: 1% |
| DC Current     | 0 to 10A                           |
| AC Current     | 0 to 10A                           |
| Resistance     | 0 to 40MΩ                          |
| Capacitance    | 0 to 100μF                         |
| Frequency      | 0~10MHz                            |

## Basic Specifications (Scope)

| Horizontal            |                                 | Vertical              |                                  |
|-----------------------|---------------------------------|-----------------------|----------------------------------|
| Sampling rate         | 40M per second                  | Bandwidth             | UT81A:2MHz,UT81B:8MHz            |
| Sampling rate / Scale | 20 pixels                       | Channel               | Single                           |
| Updating rate         | >5                              | Coupling              | DC                               |
| Trigger types         | Free Run / Normal / Single Shot | Voltage resolution    | 8 Bits                           |
| Timebase Range        | 100ns/div~5 sec /div (1-2-5)    | Input Impedance       | 10MΩ (excluding Multimeter part) |
| Timebase accuracy     | ±(0.1% + 1pix)                  | Accuracy              | ±(5%+1pix)                       |
|                       |                                 | Maximum input voltage | 1000Vp-p                         |
|                       |                                 | Voltage Sensitivity   | 20mV/div~500V/div (1-2-5)        |

### Detailed Accuracy Specifications

Accuracy: ±([% of reading] + [number of least significant digits]), guarantee for 1 year.

Operating temperature: 18°C~28°C

Relative humidity: <75%RH

### A. DC Voltage

| Range | Resolution | Accuracy  | Overload Protection | Input Impedance                     |
|-------|------------|-----------|---------------------|-------------------------------------|
| 400mV | 100μV      | ±(0.8%+8) | 1000V DC or AC      | Around 10MΩ<br>(excluding waveform) |
| 4V    | 1mV        |           |                     |                                     |
| 40V   | 10mV       |           |                     |                                     |
| 400V  | 100mV      |           |                     |                                     |
| 1000V | 1V         | ±(0.1%+8) |                     |                                     |

### B. AC Voltage

*i. Under Multimeter mode*

| Range | Resolution | Accuracy   | Overload Protection | Input Impedance                     |
|-------|------------|------------|---------------------|-------------------------------------|
| 4V    | 1mV        | ±(1%+15)   | 1000V DC or AC      | Around 10MΩ<br>(excluding waveform) |
| 40V   | 10mV       |            |                     |                                     |
| 400V  | 100mV      |            |                     |                                     |
| 750V  | 1V         | ±(1.2%+15) |                     |                                     |

#### Remarks:

- Frequency Response: 40Hz ~ 400Hz
- Displays effective value of sine wave (mean value response).

ii. *Under Scope mode*

- The specification is same as ***Bi Under Multimeter mode***.
- On the top right corner of the display shows the accuracy of the frequency which is around  $\pm 2\%$ . When the LCD displays 1-10 period waveform, the reading is valid, otherwise the Meter displays “— —”

**C. DC Current**

| Range        | Resolution  | Accuracy       | Overload Protection   |
|--------------|-------------|----------------|---|
| 400 $\mu$ A  | 0.1 $\mu$ A | $\pm(1\%+8)$   | F0.5AH/250V, $\varnothing 5 \times 20$ mm   |
| 4000 $\mu$ A | 1 $\mu$ A   |                |   |
| 40mA         | 10 $\mu$ A  | $\pm(1.2\%+8)$ |   |
| 400mA        | 100 $\mu$ A |                |   |
| 4A           | 1mA         | $\pm(1.5\%+8)$ | F10AH/250V, $\varnothing 5 \times 20$ mm.<br>(Continuous measurement $\leq 10$ seconds<br>and interval more than 15 minutes.) |
| 10A          | 10mA        |                |   |



### D. AC Current

i. Under Multimeter mode

| Range  | Resolution | Accuracy  | Overload Protection   |
|--------|------------|-----------|---|
| 400μA  | 0.1μA      | ±(1.5%+8) | F0.5AH/250V, ø5×20mm  |
| 4000μA | 1μA        |           |   |
| 40mA   | 10μA       | ±(2%+8)   |   |
| 400mA  | 100μA      |           |   |
| 4A     | 1mA        | ±(2.5%+5) | F10AH/250V, ø5×20mm<br>(Continuous measurement ≤10 seconds<br>and interval more than 15 minutes.) |
| 10A    | 10mA       |           |   |

#### Remarks:

- Frequency Response: 40Hz~400Hz.
- Displays effective value of sine wave (mean value response).

ii. *Under Scope mode*

- The specification is same as ***Di Under Multimeter mode.***

On the top right corner of the display shows the accuracy of the frequency which is around  $\pm 2\%$ . When the LCD displays 1-10 period waveform, the reading is valid, otherwise the Meter displays “-----”

**E. Resistance**

| Range | Resolution | Accuracy       | Overload Protection |
|-------|------------|----------------|---------------------|
| 400Ω  | 0.1Ω       | $\pm(1.2\%+5)$ | 250VDC or AC rms    |
| 4kΩ   | 1Ω         | $\pm(1\%+5)$   |                     |
| 40kΩ  | 10Ω        |                |                     |
| 400kΩ | 100Ω       |                |                     |
| 4MΩ   | 1kΩ        | $\pm(1.2\%+5)$ |                     |
| 40MΩ  | 10kΩ       | $\pm(1.5\%+5)$ |                     |

**F. Diode Test**

| Range   | Resolution | Overload Protection | Remarks  |
|---|------------|---------------------|--|
|  | 1mV        | 250V DC or AC       | A good silicon junction drops between 0.5V and 0.8V. |

### G. Continuity Test Test

| Range | Resolution | Overload Protection | Remarks   |
|-------|------------|---------------------|---|
| •))   | 0.1Ω       | 250V DC or AC       | <ul style="list-style-type: none"> <li>● The buzzer sounds when the test resistance is <math>\leq 10\Omega</math>.</li> <li>● The buzzer does not sound when the test resistance is <math>&gt; 100\Omega</math>.</li> </ul> |

### H. Frequency and Duty Cycle %

*i. Under Multimeter mode*

| Range      | Resolution | Accuracy                   | Overload Protection |
|------------|------------|----------------------------|---------------------|
| 10Hz~10MHz | 0.001Hz    | $\pm(0.1\%+3)$             | 250V DC or AC rms   |
| 0.1%~99.9% | 0.1%       | Reading for reference only |                     |

#### Remarks:

- Input amplitude “a” as follows; (DC electric level is zero)  
 When  $\leq 1\text{MHz}$  :  $300\text{mV} \leq a \leq 30\text{Vrms}$ ;  
 When  $> 1\text{MHz}$  :  $600\text{mV} \leq a \leq 5\text{Vrms}$

### ii. Under Scope mode

- The specification is same as **Hi. Under Multimeter mode**, press **RANGE** button to toggle between frequency and duty cycle mode.
- On the top right corner of the display shows the waveform's RMS value, for reference only. When the LCD displays 1-10 period waveform cycle or the peak-peak difference value is greater than 1/3 div, the reading is valid, otherwise the Meter displays “\_\_\_\_”

### I. Capacitance

| Range       | Resolution | Accuracy                      | Overload Protection |
|-------------|------------|-------------------------------|---------------------|
| 40nF        | 10pF       | Under REL mode: $\pm(3\%+10)$ | 250V DC or AC rms   |
| 400nF       | 100pF      | $\pm(3\%+8)$                  |                     |
| 4 $\mu$ F   | 1nF        |                               |                     |
| 40 $\mu$ F  | 10nF       |                               |                     |
| 100 $\mu$ F | 100nF      | $\pm(4\%+8)$                  |                     |

**\*\* END \*\***

This operating manual is subject to change without notice.

©Copyright 2006 Uni-Trend Group Limited.  
All rights reserved.

Manufacturer:  
Uni-Trend Technology (Dongguan) Limited  
Dong Fang Da Dao  
Bei Shan Dong Fang Industrial Development District  
Hu Men Town, Dongguan City  
Guang Dong Province  
China  
Postal Code: 523 925

Headquarters:  
Uni-Trend Group Limited  
Rm901, 9/F, Nanyang Plaza  
57 Hung To Road  
Kwun Tong  
Kowloon, Hong Kong  
Tel: (852) 2950 9168  
Fax: (852) 2950 9303  
Email: info@uni-trend.com  
<http://www.uni-trend.com>